

GRAND 350
owner's manual

mobiado

Mobiado

First edition (May 2009).

This manual is published by Bonac Innovation Corporation, without any warranty. Improvements and/or changes to this manual made necessary by typographical errors, inaccuracies of current information, or improvements to programs and/or equipment, may be made by Bonac Innovation Corporation at any time and without notice.

However, any such changes shall be incorporated into new editions of this manual.

Under no circumstances shall Bonac Innovation be responsible for any loss of data or income or any special, incidental, consequential or indirect damages howsoever caused.

All rights reserved.

©Bonac Innovation Corporation, 2009

Mobiado Package Contents

- 1 Grand 350 Phone
- 1 Battery
- 1 Headset
- 1 Data Cable
- 1 Charger
- 1 Cleaning Pouch
- 1 User Guide

Safety Information

Obey all local laws. Keep your hands free to operate your vehicle.

Switch off your phone in all restricted areas, including hospitals, aircrafts, blasting areas, and during refueling at gas stations.

All wireless phones can be susceptible to interference which can affect performance.

Remember to back up all important phone information you have stored in your phone.

Keep your phone dry at all times as moisture can damage your phone. Do not place your phone in cold or hot places. Extreme temperatures can damage your phone.

Do not attempt to open your phone, non-expert handling can damage your phone.

Use only approved accessories and batteries with your phone.

Network Services

Certain functions of the phone require service from a network service provider. Not all networks provide service for all functions. Some networks may require that you make specific arrangements before using the network service. Some networks may also have limitations on how the service is used. Your service provider can give information as to which services are supported and what charges may apply.

Battery Removal

Always switch off the phone and disconnect the charger before removing the battery.

Phonemaking excellence and a philosophy of perfection... they are the reasons why you own more than just a phone when you own a Mobiado.



Luxury in Business.
The tradition continues.

Contents

1. Key Features.....	9
2. Setting Up Your Mobiado.....	12
3. Getting Started.....	20
4. General Use.....	30
5. Messaging.....	40
6. Internet.....	50
7. Travelling.....	55
8. Office Tools.....	63
9. Media.....	72
10. Customization.....	79
11. Connectivity.....	80
12. Security and Data Management.....	87
13. Care and Maintenance.....	92
14. Battery Information.....	94

1. Key Features



Read and reply to emails.



Organize your schedule.



Manage your business and personal contacts.



Make calls using voice over IP service.



Connect to WLAN.



Work with documents, spreadsheets, and presentations.



Add new applications to your phone.



Find points of interest on a map.



Switch between business and personal modes.



Control the appearance of your home screen.



Browse your company intranet.



Move your contact and calendar information from a previous device to your Mobiado.



You can access a list of available actions by scrolling to the right when this icon is visible in the home screen, Contacts, or Calendar.

▪ Mobiado Grand 350

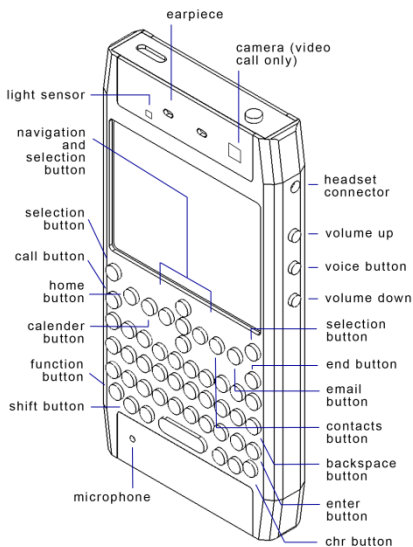

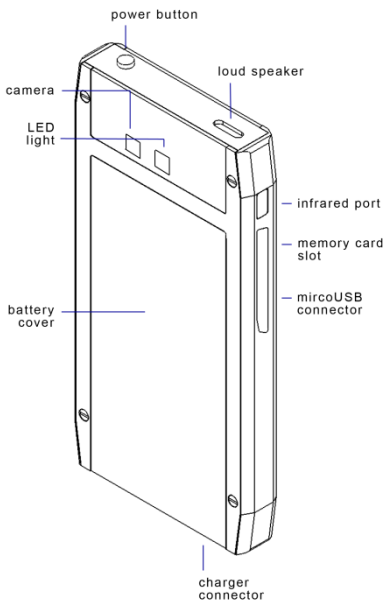

2. Setting Up Your Mobiado

▪ SIM card and battery installation

Be careful not to damage the SIM card when installing and removing. Keep out of the reach of small children.

1. Make sure the phone is turned off and remove any enhancements.
2. Slide down and remove the battery cover.

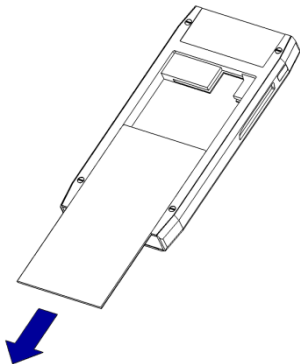

3. If the battery is inserted, remove the battery as show.

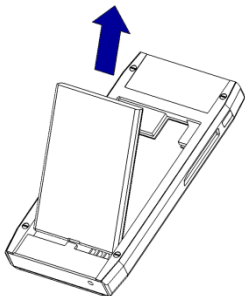

4. Insert the SIM card. Make sure the golden contact area is facing downwards and is oriented as shown.

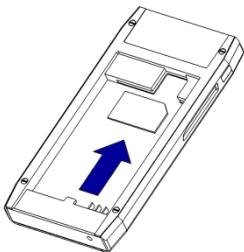

5. Replace the battery as shown, with the contacts of the battery aligned with the corresponding connectors.

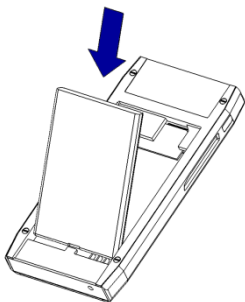

6. Slide the battery cover back into place.

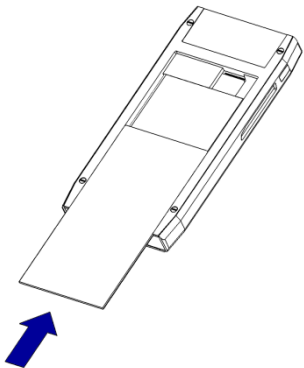

▪ Charging the battery

Connect the charger lead to the bottom of your phone, and connect the charger plug into your wall electric socket.

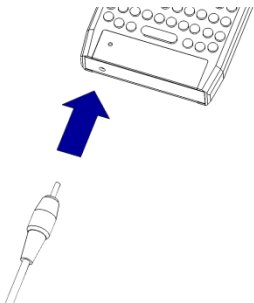

If your battery is completely discharged, it may take a few minutes for the charging to begin or before any calls can be made.

▪ Insert the memory card

1. Open the memory card slot cover.
2. Insert the memory card in the slot with the contact area going in first. Make sure the card contacts are facing the phone connectors.
3. Push the card in until it locks into place.
4. Close the slot cover.

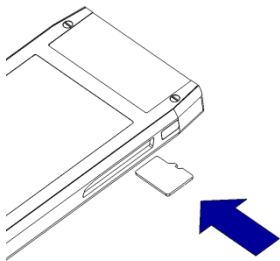

▪ Removing the memory card

Important: Do not remove the memory card in the middle of an operation that is using the card. Removing the card during an operation can cause damage to the phone and/or memory card.

1. Press the power button briefly, and select **Remove memory card**.
2. Open the memory card slot cover.
3. Press the end of the memory card to release it from the slot.
4. Close the slot cover.

- **Normal operating position**

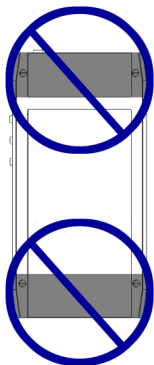

Avoid placing your fingers on the antennas when operating your phone. Your phone has a built in antenna; as with any radio transmitting device, contact with the antenna might disrupt the signal and may cause the phone to operate at a higher power consumption, thus reducing the life of the battery.

3. Getting Started

- **Switching the phone on for the first time**

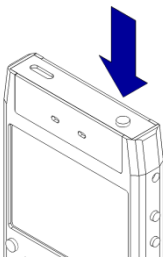

1. Press and hold the power button as shown, until the phone vibrates.
2. If the phone asks for a PIN code, key in the PIN code and press **OK**.
3. When prompted, enter the country where you are located by typing the first letters of the

country and selecting the country. It is important to select the correct country as it will affect your calendar entries if the country is changes to a country located in a new time zone.

4. When the Welcome application opens, select from the options or press Exit to close the application.

▪ **Home screen**

The Mobiado Grand has 2 available home screens that can be setup for different purposes (e.g.: business and personal).

▪ **Menu**

Select **Menu** to access all the applications on the phone and memory card. Installed application can be found in the **Installations** folder. To open an application, scroll to it and press the scroll selection key.

Press **Options** to change the view of the menu, to view the memory consumption of an application, to create or rename a folder, to move applications, or to download applications.











▪ **Switch**

Press **Menu > Tools > Switch**.

You can transfer content (e.g.: contacts) from a compatible Mobiado phone to your Mobiado Grand 350 using Bluetooth or infrared. The content that can be transferred depends on the device model. If the other Mobiado phone supports synchronization, data can be synchronized between the two devices.

To transfer data from a previous device, you may be required to insert a SIM card (however, your Mobiado Grand does not require a SIM card to transfer data).



▪ Indicators

- 3G** The phone is being used in a UTMS network.
-  Battery level.
-  You have unread messages.
-  You have new email in the remote mailbox.
-  There are messages waiting to be sent from the out folder.
-  You have one or more missed phone calls.
-  The keypad is locked.
-  The alarm clock is on.
-  Silent profile is active. The phone will not ring for an incoming call.
-  Bluetooth is active.
-  Data is being transferred using Bluetooth connectivity. When blinking, your phone is trying to connect to another device.





Data is being transferred using infrared connectivity. When blinking, your phone is trying to connect to another device.





A GPRS packet data connection is available. If the icon is  then the connection is active, or if the icon is  then the connection is on hold.





A EGPRS packet data connection is available. If the icon is  then the connection is active, or if the icon is  then the connection is on hold.



A UMTS packet data connection is available. If the icon is  then the connection is active, or if the icon is  then the connection is on hold.



A HSDPA connection is active during data transfer. If the icon is  then the connection is active, or if the icon is  then the connection is on hold.



You have scanned for WLANs and a WLAN is available.



A WLAN connection is active in a network that does not have encryption.



A WLAN connection is active in a network that does have encryption.



Your phone is connected to a computer via USB data cable.



The second phone line is being used (network service).



All calls are forwarded to another number. (If you have 2 phone lines, a number will indicate the active line.)







A headset is connected to your phone.



The Bluetooth connection to a headset has been lost.



A hands-free car kit is connected to your phone.

-  A loopset is connected to your phone.
-  A text phone is connected to your phone.
-  Your phone is synchronizing.
-  You have an ongoing push-to-talk connection.
-  Your push-to-talk connection is in the “do not disturb” mode. In this mode you cannot make PTT calls because your ringer type is set to **Beep once** or **Silent**, or you have an incoming or outgoing phone call.

▪ Common Actions

To change the profile, switch off the phone, or lock the phone, press the power button briefly.

If an application consists of several tabs, press left or right to open the desired tab.

To save the setting in an application, select **Back**.

To save a file, press **Options > Save**.

To send a file, press **Options > Send**.

To copy, press and hold the shift key, and select the text with the scroll key. Press and hold the shift key, and press **Copy**. To paste, scroll to where you want to paste the text, press and hold the shift key, and press **Paste**. The method may not work with applications that have their own copy and paste commands.

To select different items, scroll to the item and press **Options > Mark/Unmark > Mark** to select on item or press **Options > Mark/Unmark > Mark all**, to select all items. (Note: The easiest way to select the majority of items is to first press **Options > Mark/Unmark > Mark all** and then to unselect the items you do not want select by pressing **Options > Mark/Unmark > Unmark**.)

To select an object, scroll to the object so that a square maker appears on either side of the object.

▪ **Keypad lock**

The keypad can be locked in the home screen by pressing the left selection key and the function key as shown below.

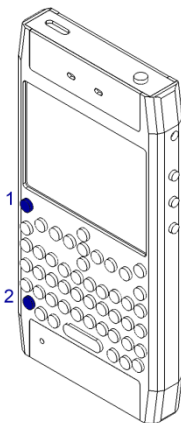

The keypad can be locked in the menu or in open application by pressing the power key briefly and selection **Lock Keypad**.

The keypad can be unlocked by pressing the left selection key and the function key.

▪ **Memory**

The Mobiado Grand has two types of memory for storing data and applications; phone memory and memory card.

This phone uses microSD and microSDHC memory cards.

To change the name of the memory card, press **Options** > **Memory card name**.

4. General Use

- **Making a call and organizing contacts**

Type in the phone number.

For international calls, add the “+” symbol (this replaces the international access code). Type in the country code without the leading “0”, if necessary, and then type in the number.

Press the call key to call.

Press the end key to end or cancel the call.

Press the volume keys to increase and decrease the volume during a call.

Search for a contact phone number by pressing the contacts key, type in the first few letters of the name and scroll down to the desired contact and press the call key.

▪ **Answering and rejecting calls**

Press the call key to answer a call and end key to reject or to end a call.

Press **Silence** to mute a ring tone.

If you receive a call during another call, press the call key to answer the second call and put the first call on hold. Press the end key to end the active call.

To switch from a voice call to a video call, press **Options** > **Switch to video call**. Your phone will end the voice call and will make a video call to the recipient.

▪ **Make a conference call**

1. To make a conference call, enter a participant's phone number, and press the call key.
2. When the participant answers, press **Options** > **New call**.

3. When you have made phone calls to all desired participants, press **Options** > **Conference** to merge the calls into a conference call.

To mute the microphone of your phone during the call, press **Options** > **Mute**.

To drop a participant from the conference call, scroll to the participant, and press **Options** > **Conference** > **Drop participant**.

To talk privately with one of the conference call participant, scroll to the participant, and press **Options** > **Conference** > **Private**.

▪ **Making data and fax calls**

To make and receive fax calls, connect your phone to a compatible computer or fax machine. To activate the fax modem, press **Options** > **Activate modem**. Only the computer or fax machine can be used to answer incoming fax calls when connected to your phone.

Reject an incoming data or fax call by pressing **Options** > **Reject**.

Reject a call while a data or fax call is in progress by pressing **Reject**.

A data or fax call cannot be put on hold.

▪ **Making video calls**

You need to be in the coverage of a UMTS network to be able to make a video call. Please contact your network operator or provider for information about service availability. Note that video calls can only be made between two parties.

Warning: In loudspeaker mode, do not hold your phone close to your ears as the volume may be extremely loud and can cause damage to your ears.

Enter the phone number or select the recipient of the call from Contacts, and press **Options** > **Call** > **Video call**. When the video call starts, the camera of the phone will be activated. If the camera was already in use, video

sending will be disabled. If the recipient of the call is unwilling to send a video back to you, a still image will be shown instead.

▪ **Making net calls**

Your phone must be within WLAN coverage to be able to make or receive a net calls. The availability of the net call service may vary according to your country or area.

Before you can make net calls, you will need to create a net call profile.

1. Press **Menu** > **Tools** > **Settings** > **Connection** > **SIP settings** > **Options** > **New SIP profile**, and enter the required information. To make the login to the net call service automatic, press **Registration** > **Always on**. Contact your net call provider for the correct settings.

2. Press **Back** until you return to the **Connection** settings main view.

3. Press **Internet tel.** > **Options** > **New profile**. Enter a name for the profile, and select the SIP profile you just created.

To set the created profile to be used automatically when connecting to the net call service, press **Menu** > **Communic.** > **Internet tel.** > **Preferred profile**.

You can make a net call where you can make a regular voice call. For example in Contacts, scroll to the desired recipient, and press **Call** > **Internet call**. To make a net call in the home screen, enter the SIP address, and press the call key.

To set net call as the preferred call type for outgoing calls, press **Menu** > **Communic.** > **Internet tel.** > **Options** > **Settings** > **Default call type** > **Internet call**. When your phone is connected to a net call service, all calls will be made as net calls.

▪ **Speed dialing**

Press **Menu** > **Tools** > **Settings** > **Phone** > **Call** > **Speed dialing** > **On**. Speed dialing allows you to make a call by pressing and holding a number key when in the home screen.

You can assign a speed dial number to a phone number by pressing **Menu** > **Communic.** > **Speed dial**. Scroll to the number key (2 - 9) on the display, and press **Options** > **Assign**. Select the desired number from Contacts. To delete the phone number assigned to a number key, scroll to the speed dialing key, and press **Options** > **Remove**. To modify a phone number assigned to a number key, scroll to the speed dialing key, and press **Options** > **Change**.

▪ **Call forwarding**

Forward incoming calls to your voice mailbox or to another phone number by pressing **Menu** > **Tools** > **Settings** > **Phone** > **Call divert**. For details, contact your service provider.

▪ **Voice Mail**

Press **Menu** > **Communic.** > **Call mailbox**. you will be asked to enter the number of your voice mailbox when opening the Voice mail application for the first time.

To call your voice mail, press **Options** > **Call voice mailbox**.

If you have an internet call mailbox, you can call it by pressing **Internet call mailbox** > **Options** > **Call internet call mbx..**

When in the home screen, you can call your voice mail by pressing and holding **1**; or press **1** and then the call key. If you have defined an internet call mailbox, select whether you want to call your voice mail or internet call mailbox.

▪ **Push to talk**

Press **Menu** > **Communic.** > **PTT**.

You can use your phone as a walkie-talkie with PTT. You can use PTT to

have a conversation with one person or with a group of people, or join to a channel.

Press **Options** > **Settings** and press **User settings** to define your preferences for PTT, or **Connection settings** to change the connection details. Contact your service provider for the correct settings.

If you have set **Application start-up** on in **User settings**, PTT automatically logs in to the service when started. If not, you must log in manually. To log in to the PTT service manually, press **Options** > **Log in to PTT**.

Warning: In loudspeaker mode, do not hold your phone close to your ears as the volume may be extremely loud and can cause damage to your ears.

To make a PTT call, press **Options** > **Contacts**, select one or several contacts from the list, and press the voice key. Remember to hold the phone in front of you during the call so that the display will be visible. The display informs you when it is your turn to

speak. Speak towards the microphone, and do not cover the loudspeaker with your hands. Press and hold the voice key the entire time you are talking. When you have finished talking, release the key.

To end the PTT call, press the end key. When you receive a PTT call, press the call key to answer the call or the end key to dismiss the call.

▪ **Log**

Press **Menu** > **Log**.

Log stores information about the communication history of the phone. The phone registers missed and received calls only if the network supports these functions, the phone is switched on and within the network service area.

To view recently missed, received, and dialed calls, press **Recent calls**.

Tip: To open **Dialed numbers** when in the home screen, press the call key.

5. Messaging

Press **Menu** > **Communic.** > **Messaging.**

▪ **Email messages**

Press **Menu** > **Messaging** > **Mailbox.** You must have a remote mailbox service to receive and send email. Your phone is compliant with internet standards SMTP, IMAP4 (revision 1), and POP3, and with different vendor-specific email solutions. Other email providers may offer services with different settings or features than those described in this user guide. Contact your email provider or service provider for more details.

▪ **Mail for exchange**

1. In the home screen, scroll to the email wizard, and press the scroll key.
2. Press **Start e-mail setup.**

3. Read the information on the display, and press **Start**.
4. Press **Yes** to allow your phone to access the network.
5. Enter your email address, and press **OK**.
6. Enter your password, and press **OK**.
7. Enter your user name, and press **OK**.
8. Press **Mail for Exchange**.
9. Enter the domain name of your network, and press **OK**.
10. Enter the Mail for Exchange server name, and press **OK**.
11. Press **Yes** to install the Mail for Exchange application to your phone.

▪ **Regular POP or IMAP email**

1. Go to the home screen, scroll to the email wizard, and press the scroll key.

2. Press **Start e-mail setup**.
3. Read the information on the display, and press **Start**.
4. Press **Yes** to allow your phone to access the network.
5. Press **E-mail**.
6. Enter your email address, and press **OK**.
7. Enter your password, and press **OK**.
8. If requested, select an internet access point that is used for connecting to your POP or IMAP email account.
9. Read the information on the display, and press **OK** to finalize email setup.

The name of your new mailbox replaces **Mailbox** in the Messaging main view.

▪ **Connect to a remote mailbox**

Email addressed to you is not automatically received by your phone,

but by your remote mailbox. You must first connect to the remote mailbox to read your e-mail; then select the email messages you wish to retrieve into your phone.

1. To retrieve received email messages to your phone and view them, select your mailbox in the Messaging main view. When the phone asks **Connect to mailbox?**, press **Yes**.

2. Enter your user name and password, if prompted.

3. Press **Options** > **Retrieve e-mail** > **New** to retrieve new messages that you have neither read nor retrieved, **Selected** to retrieve only messages you select from the remote mailbox, or **All** to retrieve all messages not previously retrieved.

4. To manage your email offline to save in connection costs and work in conditions that do not allow a data connection, press **Options** > **Disconnect** to disconnect from the remote mailbox. Any changes you make in the remote mailbox folders while

offline, take effect in your remote mailbox the next time you go online and synchronize.

▪ **Read and reply to email**

To read a received e-mail, open it from the mailbox.

To open an attachment, press **Options** > **Attachments**. Scroll to the attachment, and press the scroll key.

To reply only to the sender of an e-mail, press **Options** > **Reply** > **To sender**.

To reply to all recipients of an e-mail, press **Options** > **Reply** > **To all**.

To forward an e-mail, press **Options** > **Forward**.

To attach a file to an email message, press **Options** > **Insert** and the attachment you want to add.

To delete an attachment from an email that you are sending, select the attachment and **Options** > **Remove**.

To set the message priority, press **Options** >

Sending options > **Priority**.

To set the sending time for the email message,

press **Options** > **Sending options** >

Send message. Press **Immediately**, or

press **When conn. avail**. If you are working offline. To call the sender of the

email message, if the sender can be found in Contacts, press **Options** > **Call**. To reply to the sender of the email with an audio message or multimedia message, press **Options** > **Create message**.

▪ **Write and send email**

1. To write an e-mail, press **New message** > **Email**.
2. Press **Options** > **Add recipient** to select the recipients' email addresses from Contacts, or enter the email addresses in the **To** field. Use a semicolon to separate entries. Use the **Cc** field to send a copy to other recipients, or the **Bcc** field to send a blind copy to recipients.
3. In the **Subject** field, enter the subject of the e-mail.
4. Enter your email message in the text area, and press **Options** > **Send**.

▪ **Delete messages**

To delete email from the phone only, and keep the original on the server,

press **Options** > **Delete** > **Phone (header remains)**. To delete email both from the phone and the remote server, press **Options** > **Delete** > **Phone and server**. To cancel the deleting, press **Options** > **Restore**.

▪ **Text messages**

Press **Menu** > **Communic.** > **Messaging**.

1. To write a text message, press **New message** > **Text message**.
2. In the **To** field, enter a recipient's number, or press the scroll key to add a recipient from Contacts. If you enter more than one number, separate the numbers with a semicolon.
3. Enter the text of the message. To use a template, press **Options** > **Insert** > **Template**.
4. Press **Options** > **Send**.

▪ **Create and send multimedia messages**

1. To create a new message, press **New message** > **Multimedia message**.

2. In the **To** field, enter a recipient's number or email address, or press the scroll key to add a recipient from Contacts. If you enter more than one number or email address, separate them with a semicolon.

3. In the **Subject** field, enter a subject for the message. To change the fields that are visible, press **Options** > **Address fields**.

4. Enter the text of the message, and press **Options** > **Insert object** to add media objects. You can add objects such as **Image**, **Sound clip**, or **Video clip**.

5. Each slide of your message can contain only one video or sound clip. To add more slides to your message, press **Options** > **Insert new** > **Slide**. To change the order of slides in your message, press **Options** > **Move**.

6. To preview a multimedia message before sending it, press **Options** > **Preview**.

7. Press **Options** > **Send**. To delete an object from a multimedia message, press **Options** > **Remove**. To set the sending options for the current multimedia message, press **Options** > **Sending options**.

▪ **Instant messaging (IM)**

Press **Menu** > **Communic.** > **IM**.

Contact your service provider for more information about signing up for IM services and costs of the services.

To define the IM application settings, press **Options** > **Settings** > **IM settings**. To add an IM server, press **Options** > **Settings** > **Servers**. Ask your service provider for the correct settings.

To start a IM conversation, press **Conversations**.

To search for IM users and user IDs, press **IM contacts** > **Options** > **New IM contact** > **Search**. You can search by **User's name**, **User ID**, **Phone number**, and **E-mail address**. To close the conversation, press **Options** > **End conversation**. To start a new conversation, press **Options** > **New conversation**. You can start a new conversation with a contact while you are inside an active conversation. However, you cannot have two active conversations with the same contact.

6. Internet

Press **Menu** > **Web**.

Check the availability of services, pricing, and fees with your service provider, as well as instructions on how to use their services.

To browse the web, select a bookmark or enter the web address manually, and press **Go to**. Use only services that you trust and that offer adequate security and protection against harmful software.

To view a bookmarked web page, scroll to the bookmark, and press the scroll key. To browse to another web page, press **Options** > **Navigation options** > **Go to web address**, enter the page address, and press **Go to**. To add a bookmark, press **Options** > **Bookmark manager** > **Add bookmark**.

To view the browser page offline and to end the connection, press **Options** > **Tools** > **Disconnect**. To close the

browser and end the connection, press **Options > Exit**.

▪ **Browse the intranet**

Press **Menu > Office > Intranet**.

To browse your company's intranet, you must create a company-specific VPN policy. Press **Menu > Tools > Settings > Connection > VPN**.

To connect to the intranet, open the Intranet application, select the connection method and **Options > Connect**. To define which VPN profile to use in the connection, press **Options > Use other VPN policy**.

To define the settings for the intranet connection, press **Options > Settings**.

▪ **Download**

Press **Menu > Download!**.

With Download! (network service), you can browse, download, and install items, such as latest applications and

related documents, to your phone from the web.

- **Setup an internet access point for packet data (GPRS)**

1. Press **Menu > Tools > Settings > Connection > Access points**.

2. Press **Options > New access point** to create a new access point, or select an existing access point from the list and then **Options > Duplicate access point** to use the access point as a basis for the new one.

3. Define the settings.

4. After defining the settings, press **Options > Advanced settings** to define the advanced settings or **Back** to save the settings and exit.

▪ **Setup an access point for WLAN manually**

1. Press **Menu > Tools > Settings > Connection > Access points**.

2. Press **Options > New access point** to create a new access point, or select an existing access point from the list and then **Options > Duplicate access point** to use the access point as a basis for the new one.

3. Define the settings.

▪ **Connect a PC to the web**

You can use your phone to connect your PC to the web.

1. Connect the data cable to the USB connectors of your phone and your PC.

2. Press **Connect PC to Net**. The necessary Windows software is installed to your PC.

3. Accept the installation in your PC. If asked, accept also the connection.

When the connection between your phone and PC is established, the internet browser of your PC opens. You must have administrator rights to your PC, and the autorun option enabled in the PC.

7. Travelling

If your phone cannot find the satellite signal, consider the following solutions:

- If you are indoors, go outdoors to receive a better signal.
- If you are outdoors, move to a more open space.
- Ensure that your hand does not cover the GPS antenna of your phone (top of the phone).
- If the weather conditions are bad, the strength of the signal may be affected.
- Establishing a GPS connection may take from a couple of seconds to several minutes.

To check whether your phone is receiving satellite signals, and how many satellites your phone has found, press **Menu > GPS > GPS data > Position > Options > Satellite status.**

▪ **Maps**

Press **Menu** > **GPS** > **Maps**.

To zoom in to your GPS position or your last known location, press **0**. When the GPS connection is active, shows your current location on the map. To move on the map, scroll up, down, left, or right with the scroll key. The map is oriented towards north by default. To zoom in and out on the map, press ***** and **#**.

These maps are free of charge, but downloading them may involve the transmission of large amounts of data through your service provider's network. For more information on data transmission charges, contact your service provider.

▪ **Display indicators**

The GPS indicator is located on the bottom right corner of the display. It shows the availability and strength of the satellite signal (one bar is one satellite). When the phone is trying to find a satellite, the bar is yellow. When

the phone receives enough data from the satellite to establish a GPS connection, the bar will turn green. The more green bars, the stronger the GPS connection.

▪ Find locations

To find a location in the city or area displayed on the map, enter the full or partial address of the location in the search field, and press the scroll key. To find a location in another city, enter the city and the full or partial address, and press the scroll key. To find a specific address, or an address in another country, press the scroll key, and press **Search > Addresses. Country/Region** * (**City or post code** are mandatory). To import a location address from the Contacts application, press the scroll key and press **Search > Addresses > Options > Contact.**

▪ Plan a route

To plan a route, select your start point on the map or search for a location, press the scroll key, and press **Add > To route**. To define the destination and add more locations for your route, search for the location, and press **Options > Add route point**. To show the route on the map, press **Options > Show route**. To navigate to the destination by car or on foot, if you have purchased a license for these extra services, press **Options > Start driving** or **Start walking**. To save the route, press **Options > Save route**.

▪ Walk to your destination

To purchase a license for pedestrian navigation, press **Options > Extras > Walk**. The license is region-specific and can be used only in the selected area. You can pay for the license through a credit card or in your phone bill, if it is supported by your service provider. To start navigating, select a location and **Options > Walk to**. To find an alternative route, press **Options >**

Different route. To stop navigating, press **Options** > **Stop navigation**.

▪ **Drive to your destination**

To purchase a license for pedestrian and car navigation with voice guidance, press **Options** > **Extras** > **Drive & Walk**. The license is region-specific and can be used only in the selected area.

To start navigating by car, select a location, press the scroll key, and press **Drive to**. When you use car navigation for the first time, you are asked to select the language of the voice guidance and download the related voice guidance files. To change the language later, in the main view, press **Options** > **Tools** > **Settings** > **Navigation** > **Voice guidance**. Voice guidance is not available for pedestrian navigation.

To switch between different views during the navigation, press the scroll key, and press **Manoeuvre view**, **Bird's-eye view**, or **Arrow view**.

To find an alternative route, press **Options** > **Diff. route**. To repeat the voice guidance, press **Options** >

Repeat. To stop navigating, press **Options > Stop navigation.**

▪ **Traffic information**

To purchase a license for the traffic information service, press **Options > Extras > Traffic info.** To view information about traffic events, press **Options > Traffic info.** The events are shown on the map as triangles and lines. To view the details of an event, including possible rerouting options, select the event and **Options > Open.** To update the traffic information, press **Update traffic info.**

▪ **Travel guides**

The guides must be purchased and downloaded before use. Downloading travel guides may involve the transmission of large amounts of data through your service provider's network. Contact your service provider for information about data transmission charges. To purchase and download travel guides, or to view downloaded

ones, press **Options** > **Extras** > **Guides**.

▪ **GPS data**

Press **Menu** > **GPS** > **GPS data**. Press **Navigation** to view navigating information to your trip destination, **Position** to view positioning information about your current location, or **Trip dist.** to view your travelling information such as the distance and duration you have travelled, and your average and maximum speeds.

▪ **Landmarks**

Press **Menu** > **GPS** > **Landmarks**. Landmarks are coordinates to geographic locations that you can save to your phone for later use in different location based services.

▪ **Create a landmark**

To create a landmark, press **Options** > **New landmark**. Press **Current**

position to make a network request for the latitude and longitude coordinates of your current location, **Use map** to select the location from a map, or **Enter manually** to fill in necessary location information such as a name, category, address, latitude, longitude, and altitude. To show the landmark on the map, press **Options** > **Show on map**.

8. Office Tools

- **Active notes**

Press **Menu** > **Office** > **Active notes**.

To create a note, start writing. To edit a note, scroll to it, and press the scroll key. To insert images, sound clips, video, business cards, web bookmarks, and files, press **Options** > **Insert object**.

To add new items to the note, press **Options** > **Insert new**. You can record sound and video clips, and capture images.

To add boldface, italics, or underlining to your text or change the font color, press and hold the shift key and use the scroll key to select the text. Then press **Options** > **Text**.

To send the note using a text message, multimedia message, e-mail, Bluetooth, or infrared, press **Options** > **Send**.

To link a note to a contact, press **Options** > **Link note to call** > **Add contacts**. You can see the note on the display of your phone when making a call to or receiving a call from the contact.

▪ **Calculator**

Press **Menu** > **Office** > **Calculator**.

To make a calculation, enter the first number of the calculation. Select a function such as add or subtract from the function map. Enter the second number of the calculation, and select =.

To recall the last saved result the next time you open the Calculator application, press **Options** > **Last result**.

To save the numbers or results of a calculation, press **Options** > **Memory** > **Save**.

To retrieve the results of a calculation from the memory and use them in a

calculation, press **Options** > **Memory** > **Recall**.

▪ **File Manager**

Open the device tab or the memory card tab. To select multiple files, scroll to each file, and press **Options** > **Mark/Unmark** > **Mark**. To send the selected files, press **Options** > **Send**.

To move or copy files or folders to another folder, press **Options** > **Move to folder** or **Copy to folder**. Default folders cannot be moved.

To search for files, press **Options** > **Find**. Enter the search text, and press the scroll key. The files and folders whose names contain the search text are displayed.

▪ **Quickoffice**

Press **Menu** > **Office** > **Quickoffice**. Quickoffice consists of Quickword for Microsoft Word, Quicksheet for Microsoft Excel, Quickpoint for Microsoft

PowerPoint, and Quickmanager for purchasing software. You can view Microsoft Office 2000, XP, and 2003 documents (*.doc, *.xls, and *.ppt) with Quickoffice. If you have the editor version of Quickoffice, you can also edit files. All file formats or features are not supported.

▪ **Convertor**

Press **Menu** > **Office** > **Converter**. The converter has limited accuracy, and rounding errors may occur.

1. Scroll to the **Type** field, and press **Options** > **Conversion type** to open a list of measures. Select the measure to use, and press **OK**.
2. Scroll to the first **Unit** field, and press **Options** > **Select unit**. Select the unit from which to convert, and press **OK**. Scroll to the next **Unit** field, and select the unit to which to convert.
3. Scroll to the first **Amount** field, and enter the value to convert. The other

Amount field changes automatically to show the converted value.

1. To set the rate of exchange for the unit of currency, scroll to the **Type** field, and press **Options** > **Currency rates**.

2. Scroll to the currency type and enter the exchange rate you would like to set per single unit of currency.

3. To change the base currency, scroll to the currency, and press **Options** > **Set as base currency**.

4. Press **Done** > **Yes** to save the changes.

After you have inserted all the necessary exchange rates, you can make currency conversions.

▪ **ZIP manager**

Press **Menu** > **Office** > **Zip**. With Zip manager, you can create new archive files to store compressed ZIP formatted files; add single or multiple

compressed files or directories to an archive; set, clear, or change the archive password for protected archives; and change settings, such as compression level, and file name encoding. You can store the archive files on the phone memory or on a memory card.

▪ **PDF reader**

Press **Menu > Office > Adobe Reader**. With PDF reader you can read PDF documents on the display of your phone; search for text in the documents; modify settings, such as zoom level and page views; and send PDF files using e-mail.

▪ **Printing**

To configure a printer for your phone, press **Menu > Office > Printers > Options > Add**. To set the printer as the default printer, press **Options > Printing options > Printers**, scroll to the printer and press **Options > Set as default**.

Before you print, make sure your phone is properly connected to the printer. To print a document, press **Options** > **Printing options** > **Print**. To print to a file, press **Options** > **Printing options** > **Print** > **Print to file**, and determine the location for the file.

▪ **Clock**

Press **Menu** > **Office** > **Clock**. Open the alarm clock tab. To set an alarm, press **Options** > **New alarm**. When an alarm is active, is displayed.

To switch off the alarm, press **Stop**, or to stop the alarm for 5 minutes, press **Snooze**. If the alarm time is reached while the phone is switched off, the phone switches itself on and starts sounding the alarm tone. If you press **Stop**, the phone asks whether you want to activate the phone for calls. Press **No** to switch off the phone or **Yes** to make and receive calls. Do not press **Yes** when wireless phone use may cause interference or danger. To change the alarm time, press **Options** > **Reset**

alarm. To remove the alarm, press **Options > Remove alarm.**

▪ **Notes**

Press **Menu > Office > Notes.** To write a note, start entering the text. The note editor opens automatically. To open a note, scroll to it, and press the scroll key. To send a note to other compatible devices, press **Options > Send.**

▪ **Wireless keyboards**

1. Activate Bluetooth connectivity on your phone: press **Menu > Connectivity > Bluetooth > Bluetooth > On.** Make sure that you have set **My phone's visibility > Shown to all.**

2. Switch on the keyboard.

3. Press **Menu > Office > Wlss. keybd..**

4. To start searching for devices with Bluetooth connectivity, press **Options** > **Find keyboard**.
5. Select the keyboard from the list, and press the scroll key to start the connection.
6. To pair the keyboard with your phone, enter a passcode of your choice (1 to 9 digits) on the device and the same passcode on your keyboard.
7. If you are asked for a keyboard layout, select it from a list on your phone.

When the name of the keyboard appears, its status changes to **Keyboard connected**, and the indicator of your keyboard blinks slowly; the keyboard is ready for use.

9. Media

▪ Camera

Press **Menu** > **Media** > **Camera**.

To capture an image, use the display as a viewfinder and press the scroll key. The phone saves the image in Gallery. To zoom in or out before capturing an image, scroll up or down. To focus on the subject before capturing the image, press the T key.

To change the scene, press **Scene modes** in the toolbar.

If you do not want to keep the image, press **Delete** from the toolbar.

▪ Video

1. If the camera is in the image mode, select the video mode from the toolbar.
2. To start recording, press the scroll key.

3. To pause recording at any time, press **Pause**. Press **Continue** to resume recording.

4. To stop recording, press **Stop**. The video clip is automatically saved in Gallery. Maximum length of the video clip depends on the available memory.

To play a recorded video clip, press **Play** from the toolbar.

▪ **Podcasting**

Press **Menu** > **Media** > **Podcasting**.

Press **Options** > **Settings** > **Connection** and **Download**. To search for new podcast episodes to subscribe to, press **Directories**. To search for podcasts using keywords and podcast show titles, press **Search**.

To display the available episodes from the selected podcast, open the **Podcasts** folder and press **Open**.

To download the selected episode, press **Download**. To play the downloaded episode, press **Play**.

Press **Directories**. Directories help you find new podcast episodes to which to subscribe. To subscribe to a podcast, scroll to the podcast title and press **Update**. After you have subscribed to episodes of a podcast, you can download, manage, and play them in the podcasts menu.

▪ **Music player**

Warning: Only listen to music at a moderate level. Continuous exposure to high volume may damage your hearing. In loudspeaker mode, do not hold your phone close to your ears as the volume may be extremely loud and can cause damage to your ears.

Press **Menu > Media > Music player**. Music player supports files formats such as AAC, AAC+, eAAC+, MP3, and WMA.

To fast forward or rewind, press and hold the scroll key to the right or left. To go to the next item, scroll right. To return to the beginning of the item, scroll left. To skip to the previous item, scroll

left again within 2 seconds after a song or podcast has started.

▪ **Playlists**

To view and manage playlists, press **Music > Playlists**. To create a new playlist, press **Options > Create playlist**. To add songs to the playlist, select the song and **Options > Add to a playlist > Saved playlist** or **New playlist**. To reorder songs in a playlist, scroll to the song you want to move, and press **Options > Reorder list**.

▪ **Transfer music from PC**

To transfer music from your PC, connect your phone to the PC with a compatible USB data cable or Bluetooth connectivity. If you are using the USB cable, press **Mass storage** as the connection mode. Make sure that a compatible memory card is inserted in the phone.

▪ Recorder

Press **Menu** > **Media** > **Recorder**. You can also press the voice key to open the Recorder application.

To record a sound clip, press **Options** > **Record sound clip**. Press **Pause** to pause the recording, and **Record** to resume recording. When you finish recording, press **Stop**. The sound clip is automatically saved to the Sound clips folder in Gallery.

To listen to the sound clip that you just recorded, press **Play**. The progress bar displays the playing time, position, and length of the clip. Press **Stop** to cancel the playback. To pause the playback of a recorded clip, press **Pause**. Playback resumes when you press **Play**.

▪ Gallery

Press **Menu** > **Media** > **Gallery**.

To open an image for viewing, press **Options** > **Open**. To open the next or previous image for viewing, scroll right

or left.

▪ **RealPlayer**

Press **Menu** > **Media** > **RealPlayer**.

Warning: In loudspeaker mode, do not hold your phone close to your ears as the volume may be extremely loud and can cause damage to your ears.

To play a video clip or audio file, press **Options** > **Open** > **Most recent clips** to play one of the six clips you most recently played, or **Saved clip** to play a clip or open a web link. Press **Play**.

To stop the playback or streaming, press **Stop**.

▪ **Radio**

Warning: In loudspeaker mode, do not hold your phone close to your ears as the volume may be extremely loud and can cause damage to your ears.

To search for a station, select or . To set the frequency manually, press **Options**

> **Manual tuning**. To view available stations based on location, press **Options** > **Station directory** (network service). To save the current station to your station list, press **Options** > **Save station**.

10. Customization

▪ Profiles

Press **Menu** > **Tools** > **Profiles**.

To create a new profile, press **Options** > **Create new**, and define the settings. To customize a profile, select a profile and **Options** > **Personalise**. To change a profile, select a profile and **Options** > **Activate**. To delete a profile that you created, press **Options** > **Delete profile**. You cannot delete the predefined profiles.

▪ Select ringtones

To set a ringtone for a profile, press **Options** > **Personalise** > **Ringtone**. Select a ringtone from the list, or press **Download sounds** to open a bookmark folder containing a list of bookmarks for downloading tones using the browser. Any downloaded tones are saved to Gallery.

11. Connectivity

▪ Data cable

To avoid damaging the memory card, do not remove the data cable in the middle of a data transfer.

1. Insert a memory card to your phone and connect the phone to a compatible PC with the USB data cable.
2. When the phone asks which mode is used, press **Mass storage**. In this mode, you can see your phone as a removable hard drive in your computer.
3. End the connection from the computer (for example, from an Unplug or Eject Hardware wizard in Windows) to avoid damaging the memory card.

▪ Infrared

Do not point the infrared (IR) beam at anyone's eye or allow it to interfere with other IR devices. This phone is a Class 1 laser product.

1. Ensure that the infrared ports of the devices face each other.
2. Press **Menu** > **Connectivity** > **Infrared** to switch on infrared on your phone.
3. Switch on infrared on the other device and wait a few seconds until the infrared connection is established.
4. Locate the desired file in an application or File manager, and press **Options** > **Send** > **Via infrared**.

If the data transfer is not started within 1 minute after the activation of the infrared port, the connection is cancelled and must be started again. All items received through infrared are placed in the Inbox folder in Messaging.

▪ Bluetooth

Press **Menu** > **Connectivity** > **Bluetooth**.

1. When you activate Bluetooth for the first time, you are asked to give a name to your phone.

2. Press **Bluetooth** > **On**.

3. Press **My phone's visibility** > **Shown to all** or **Define period**.

4. Open the application where the item you want to send is stored.

5. Select the item, and press **Options** > **Send** > **Via Bluetooth**. The phone searches for other devices using Bluetooth technology within range and lists them.

6. Select the device with which you want to connect. If the other device requires pairing before data can be transmitted, you are asked to enter a passcode. When the connection has been established, **Sending data** is shown.

To receive data using Bluetooth, press **Bluetooth > On** and **My phone's visibility > Shown to all** to receive data from a non-paired device or **Hidden** to receive data from a paired device only.

▪ **Pair devices**

1. Press **Options > New paired device**. To search for more Bluetooth devices, press **More devices**.

2. Select the device with which you want to pair, and enter the passcode. The same passcode must be entered to the other device as well.

3. Press **Yes** to make the connection between your phone and the other device automatic, or **No** to confirm the connection manually every time a connection attempt is made. To delete a pairing, select the device whose pairing you want to delete and **Options > Delete**. To delete all pairings, press **Options > Delete all**.

▪ **Wireless LAN**

Important: Always enable one of the available encryption methods to increase the security of your wireless LAN connection.

To have your phone show WLAN availability, press **Menu > Tools > Settings > Connection > Wireless LAN > Show WLAN availability**.

▪ **Modem**

Press **Menu > Connectivity > Modem**.

Before you can use your phone as a modem

- You need an appropriate data communications software on your computer.
- You must subscribe to the appropriate network services from your service provider or internet service provider.
- You must have the appropriate drivers installed on your computer. You must install drivers for the cable connection, and you may need to install or update Bluetooth or infrared drivers.

To connect the phone to a compatible computer using infrared, press the scroll key. Make sure the infrared ports of the phone and computer are directly facing each other with no obstacles between them.

To connect your phone to a computer using Bluetooth wireless technology, initiate the connection from the computer. To activate Bluetooth in your phone, press **Menu > Connectivity > Bluetooth** and press **Bluetooth > On**.

If you use a cable to connect your phone to a computer, initiate the connection from the computer. You may not be able to use some of the other communication features when the phone is used as a modem.

Press **Menu > Connectivity > Conn. mgr..**

To end the selected network connection, press **Options > Disconnect**. To end all active network connections simultaneously, press **Options > Disconnect all**.

▪ Search for WLAN

To search for WLANs available within range, press **Available WLAN networks**. To view the details of a network, scroll to it, and press the scroll key. To create an internet access point for a network, press **Options > Define access point**.

12. Security and Data Management

Important: Your phone can only support one antivirus application. Having more than one application with antivirus functionality could adversely affect performance and operation or cause the phone to stop functioning.

▪ Lock the phone

The default lock code is 12345. To unlock, press the left selection key, enter your lock code, and press the scroll key. To change the lock code, press **Menu > Tools > Settings > General > Security > Phone and SIM card > Lock code**. Enter the old code and then the new code twice. The new code can be 4 to 255 characters long. Both alphabets and digits can be used, and both uppercase and lowercase alphabets are possible.

You can also lock the phone remotely by sending a text message to the phone. To enable remote locking and to define the text for the message, press **Menu > Tools > Settings > General > Security > Phone and SIM card > Allow remote lock > Yes**. Enter the remote lock message and confirm the message. The message must be at least 5 characters long.

▪ **Memory card security**

To protect a memory card with a password to prevent unauthorized access, set a password, by selecting **Options > Set password**. The password can be up to eight characters long and is case-sensitive. The password is stored in your phone. You do not need to enter it again while you use the memory card in your phone. If you use the memory card in another device, you will be asked for the password. Not all memory cards support password protection.

To remove the memory card password, press **Options > Remove password**.

To open a locked memory card, press **Options > Unlock memory card**. Enter the password. If you cannot recall the password to unlock a locked memory card, you may reformat the card, in which case the card is unlocked and password removed. To format a memory card for your phone, press **Options > Format memory card**. When a memory card is formatted, all data on the card is permanently lost. Contact your retailer to find out if you must format the memory card before you can use it.

▪ Encryption

Press **Menu > Tools > Encryption**.

To encrypt the phone memory, press **Phone memory**. To encrypt the memory card, press **Memory card** and from the either **Encrypt without saving key**, **Encrypt and save key**, or **Encrypt with restored key**.

- **Decrypt phone memory or memory card**

To decrypt the phone memory, press **Phone memory**. To decrypt the memory card without destroying the encryption key, press **Memory card > Decrypt**. To decrypt the memory card and destroy the encryption key, press **Memory card > Decrypt and turn off encryption**.

- **Backup data**

To backup information from the phone memory to a memory card, press **Menu > Tools > Memory > Options > Backup phone memory**. To restore information from the memory card to the phone memory, press **Menu > Tools > Memory > Options > Restore from card**.

▪ **Barcode reader**

Press **Menu** > **Tools** > **Barcode**.

To scan a code, press **Scan code**, and set the code between the red lines on the display. The decoded information appears on the display. To save the scanned data, press **Options** > **Save**.

The data is saved in .bcr format.

To view previously saved, decoded information in the main view, press **Saved data**.

13. Care and Maintenance

The Mobiado Grand 350 has been created from the finest of materials and must be handled with care. Only use the provided Mobiado cleaning cloth to wipe your phone. Do not use any solvents to clean your phone.

Keep your phone dry and do not store in dirty and dusty areas.

Sapphire crystal does not usually scratch, but contact with diamonds and precious stones should be avoided.

Do not store your phone in hot areas. High temperature can shorten the life of the electronics of your phone.

Do not store your phone in cold areas. Moisture can form and damage the electronics of your phone.

Do not attempt to open your phone other than instructed in this manual.

Always back up your files before sending to a service center for servicing.

Note: Damage caused by dropping your phone is not covered by the warranty.

14. Battery Information

The phone receives its power from a rechargeable battery. The battery is at maximum performance only after 2 or 3 complete cycles of charge and discharge.

The battery can be charged hundreds of times but will eventually wear out. If you notice a big change in operating time, replace your battery with a new one.

Use only batteries that are approved by the phone manufacturer. Unplug the phone once it is completely charged. Never leave the phone plugged in for longer than a week. Overcharging may shorten the life of your battery. The battery will gradually discharge by itself over time.

Extreme temperatures can affect the performance of your battery. Use the battery only for its intended use and never use a damaged battery.

Do not short-circuit the battery. This can occur if a conductive object (e.g.

metallic) contacts the terminals (+ and -) at the same time.

Do not leave your battery in hot or cold places; it may reduce the capacity and lifespan of your battery. Keep your battery between 15°C and 25°C (59°F and 77°F). A battery that is hot or cold may temporarily not work, even if fully charged.

Never discard your battery in a fire. Discard your battery according to local regulations.

CERTIFICATE OF OWNERSHIP

Mobiado Instrument

Sold Exclusively at

Date

Owner's Name

Serial Number



Peter Bonac
President

Please retain this certificate as proof of purchase.

mobiado

www.mobiado.com